

# LY SERIES

## TWO WAY FULLRANGE LOUDSPEAKER

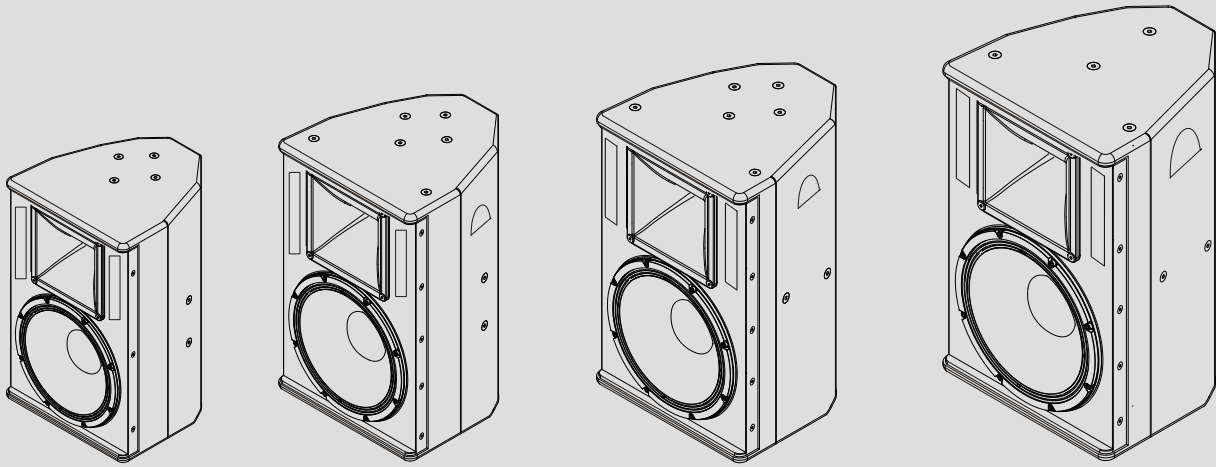

LY系列是5.S Audio十多年来技术沉淀，科研人员不断提高扬声器系统各种性能的最新智慧结晶。在设计和生产中运用了许多音箱行业行之有效的新技术措施，克服了扬声系统中散热、干涉、失真、共振等一系列问题。按照AES-2国防工业标准，扬声器单元只要通过24小时粉红噪音满功率负载不烧毁即为合格。而5.S Audio所选用的单元则把此标准提高到72个小时，这是5.S Audio对用户的保证。

LY系列所有产品均采用紧凑的多边流线型前导向设计，箱体表层采用耐磨、耐刮、防水的聚脲漆保护，同时更是根据国际声学设计特别定制了进口15mm优质的航海级桦木，箱体工艺选用德国原装高精度、高科技、全自动数字化CNC加工；高、低音单元选用欧洲原装进口定制顶级扬声器单元，使LY系列扬声器具有极高的可靠性。

LY series is technology accumulation of 5.S Audio more than a decade. The researchers continually develop on the performance of speaker system. Many new technologies and effective measures of audio industry have been applied in design and production to overcome a series of problems, such as heat dissipation, interference, distortion and resonance etc. Based on the AES-2 defense industry standard, the speaker unit will be qualified if not burnt out after 24-hour pink noise full power overload. However, 5.S Audio guarantee to the users and raises the standard to 72 hours.

LY series adopt the design of compact streamlined polygon front oriented. The enclosure surface is Polyurea Paint with durable and waterproof. And design of international acoustics customized 15mm marine-grade Birch Plywood. The process of enclosure originally from German is with high precision, high technology and full automatic digitization CNC process. The loudspeaker is with high quality for high-low module original imported and customized from European, which ensure the LY series loudspeakers with highly reliable.

- 2路高声压输出多用途全频扬声器系统 (High SPL output multi-functional full-range loudspeaker system with 2-way design)
- 90° x60° / 80° x50° 可旋转方形铸铝号角 (90° x60° / 80° x50° rotating rectangle plastic steel horn)
- 全频双通道功放驱动 ( Full-frequency dual channel amplifier drive)
- 独特的1"喉口，采用欧洲进口定制驱动单元 (1"horn unique design, customized driver originally imported from the European)
- 8"、10"、12"、15"极低失真低音单元 ( 8"&10" & 12"&15"ultra-low distortion of bass unit)
- 设计用于固定安装、高端KTV、夜总会、酒吧、中/近场扩声或私人会所等 ( Design for use in fixed installations, KTV, night club, bars, near-field/ midfield amplification and private club etc.)

# LY-08/LY-10

## FULLRANGE LOUDSPEAKER

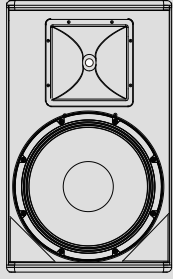

正面(Front)

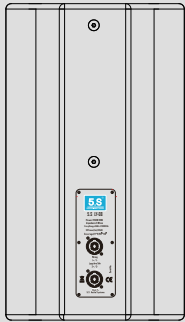

背面(Back)

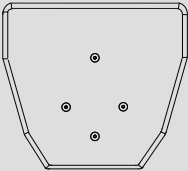

顶面(Top)

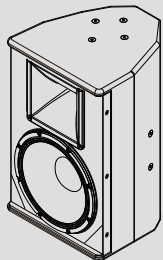

侧面(Side)

### 技术参数(Technical Parameters)

型号: (Model)	LY-08	LY-10
类型: (Type)	2路全频多用途扬声器系统(Two-way FullRange & multi-functional loudspeaker system)	2路全频多用途扬声器系统(Two-way FullRange & multi-functional loudspeaker system)
频率响应: (Frequency Response)	56Hz-20kHz	48Hz-20kHz
功率: (Rated Power)	250W	350W
峰值功率: (Peak Power)	1000W	1400W
阻抗: (Impedance)	8Ω	8Ω
覆盖角度: (Dispersion HxV)	90° *60°	90° *60°
灵敏度: (Sensitivity)	94dB	95dB
最大声压级: (SPL)	123dB	126dB
分频点: (Crossover Point)	1.8kHz 内置分频 (Passive Crossover)	1.5kHz 内置分频 (Passive Crossover)
输入连接器: (Connectors)	2*Neutrik™ 1+1-	2*Neutrik™ 1+1-
低频: (LF)	8"喇叭单元采用欧洲定制低音单元, 2"(51mm)音圈, 额定功率为:250W(AES) 8" loudspeaker, originally imported from European; Voice coil: 2" (51mm). Rated power: 250W (AES)	10"喇叭采用欧洲定制低音单元, 2.55"(64mm)音圈, 额定功率为:350W(AES) 10" loudspeaker, originally imported from European; Voice coil: 2.55" (65mm). Rated power: 350W (AES)
高频: (HF)	1"喉口喇叭单元, 采用欧洲定制压缩驱动单元, 1.5"(34mm)音圈, 额定功率为: 50W(AES) 1" horn, compression drivers originally imported from European; Voice coil: 1.5"(34mm) Rated power: 50W (AES)	1"喉口, 采用欧洲高音压缩驱动单元, 1.75"(44mm)音圈, 额定功率为: 50W(AES) 1" horn, ccompression drivers originally imported from European; Voice coil: 1.75"(44mm) Rated power: 80W (AES)
箱体材料: (Enclosure Materials)	15mm+18mm航海级桦木夹板 (15mm & 18mm marine-grade Birch Plywood)	15mm+18mm航海级桦木夹板 (15mm+18mm marine-grade Birch Plywood)
箱体表面处理: (Enclosure Paint)	黑色聚脲油漆(Black Polyurea paint)	黑色聚脲油漆(Black Polyurea paint)
尺寸: (Dimensions)	246mm*451mm*240mm(W*H*D)	306mm*510mm*320mm(W*H*D)
重量: (Weight)	11kg	16.5kg

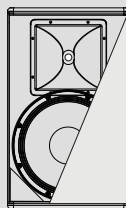
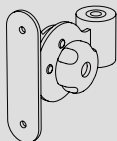

剖面(section)

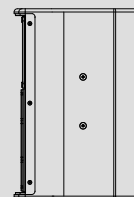

侧面(Side)



## LY-12/LY-15

### FULLRANGE LOUDSPEAKER

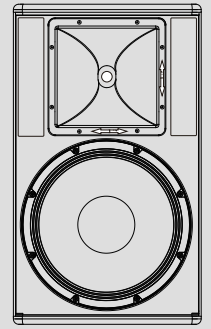

正面(Front)

#### 技术参数(Technical Parameters)

型号: (Model)	LY-12	LY-15
类型: (Type)	2路全频多用途扬声器系统(Two-way FullRange & multi-functional loudspeaker system)	2路全频多用途扬声器系统(Two-way FullRange & multi-functional loudspeaker system)
频率响应: (Frequency Response)	45Hz-20kHz	42Hz-20kHz
功率: (Rated Power)	500W	600W
峰值功率: (Peak Power)	2000W	2400W
阻抗: (Impedance)	8Ω	8Ω
覆盖角度: (Dispersion HxV)	90° *60°	80° *50°
灵敏度: (Sensitivity)	96dB	100dB
最大声压级: (SPL)	129dB	134dB
分频点: (Crossover Point)	1.3kHz 内置分频 (Passive Crossover)	1.2kHz 内置分频 (Passive Crossover)
输入连接器: (Connectors)	2*Neutrik™ 1+ 1-	2*Neutrik™ 1+ 1-
低频: (LF)	12"喇叭单元采用欧洲定制低音单元, 3"(75mm)音圈,额定功率为:500W(AES) 12" loudspeaker, originally imported from European; Voice coil: 3" (75mm). Rated power: 500W (AES)	15"喇叭采用欧洲定制低音单元, 3.2"(80mm)音圈, 额定功率为:600W(AES) 15" loudspeaker, originally imported from European; Voice coil: 3" (75mm). Rated power: 600W (AES)
高频: (HF)	1"喉口喇叭单元,采用欧洲定制压缩驱动单元, 1.75"(44.4mm)音圈,额定功率为: 70W(AES) 1" horn, customized compression drivers originally imported from European; Voice coil: 1.75"(44.4mm) Rated power: 80W (AES)	1.5"喉口,采用欧洲定制高音压缩驱动单元, 3"(75mm)音圈, 额定功率为: 150W(AES) 1.5" horn, compression drivers originally imported from European; Voice coil: 3"(75mm) Rated power: 150W (AES)
箱体材料: (Enclosure Materials)	15mm+18mm航海级桦木夹板 (15mm & 18mm marine-grade Birch Plywood)	15mm+18mm航海级桦木夹板 (15mm & 18mm marine-grade Birch Plywood)
箱体表面处理: (Enclosure Paint)	黑色聚脲油漆(Black Polyurea paint)	黑色聚脲油漆(Black Polyurea paint)
尺寸: (Dimensions)	367mm*590mm*385mm(W*H*D)	439mm*700mm*407mm(W*H*D)
重量: (Weight)	25.70kg	32.4kg

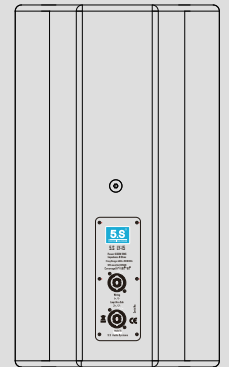

背面(Back)

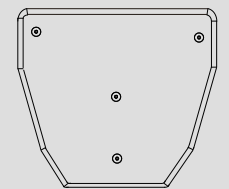

顶面(Top)

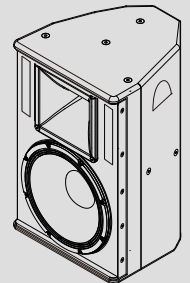

侧面(Side)

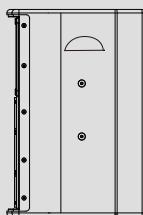

侧面(Side)

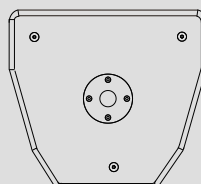

底部(Bottom)

