

HX SERIES

TWO WAY FULLRANGE LOUDSPEAKER

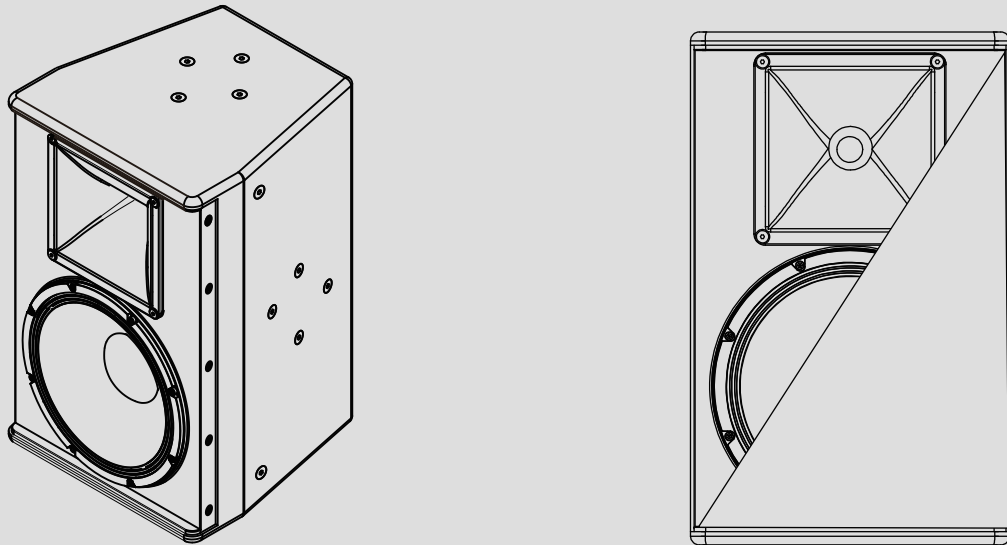

一如既往, **5.S** Audio 总是能够持续推出可以定义行业标准的产品。针对目前市场需求中的灵活性和多功能性, **5.S** 专业音响研发推出了HX系列音箱。HX系列箱体采用紧凑的对称多边形设计, 使得音箱更加美观大方, 采用15mm优质桦木板材, 独特的一体化音箱组装技术, 采用了进槽结构、冷粘接、高压定位等技艺建造箱体, 把手、支撑底座、悬挂吊点集成一体, 灵活的吊挂方式更符合声学设计要求。箱体表层采用耐磨、耐刮、防水的聚脲漆保护, 低音采用大功率极低失真低音单元, 高音采用可90° x60° 旋转方形纤维塑钢号角, 1"喉口压缩驱动单元, 可选全频双通道功放驱动, 让用户拥有更多的选择。HX系列为量贩式KTV、夜总会、俱乐部和小型活动等提供了强大扩声解决方案。

5.S Audio, as always, constantly launch the products that able to set the industry standards. **5.S** professional audio launches HX series speaker to meet the demands of the flexibility and multi-function. The enclosure of HX series is designed as compact symmetrical polygon which make the speaker looks more beautiful and elegant. The enclosure is made of international Birch Plywood with 15mm, unique integrated speaker assembly technology with the technology of inlet structure, cold bonding, high pressure positioning and so on. The handle, support base and fittings are integrated, and the flexible fittings are in conformity with acoustic design requirements. The enclosure surface are protected by Polyurea paint which is high quality of wear-resisting, scratch-resistant, and waterproof functions. The woofer use high-power ultra-low distortion bass unit, while the treble use 90° x60° rotating square plastic steel horn. 1"throat compression drivers and optional full-range dual channel amplifier driver, gives the users more choices. Design for use in fixed installations, KTV, nightclub, club, and company activities, and provide powerful solutions.

- 2路高声压输出多用途全频扬声器系统。(High SPL output multi-functional full-range loudspeaker system with 2-way design)
- 独特的1"喉口, 采用欧洲原装进口定制驱动单元。(1" horn unique design, customized driver originally imported from the European)
- 90° x60°, 可旋转方形塑钢号角。(90° x60° rotating square plastic steel horn)
- 10"、12"极低失真低音单元。(10" & 12" ultra-low distortion of bass unit)
- 全频双通道功放驱动。(Full-range dual channel amplifier driver)
- 设计用于固定安装、量贩式KTV、夜总会、俱乐部和小型活动等。(Design for use in fixed installations, KTV, nightclub, club, and company activities etc)

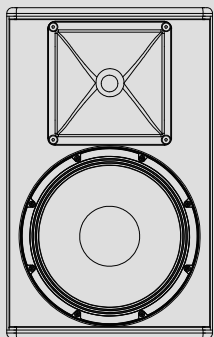

正面(Front)

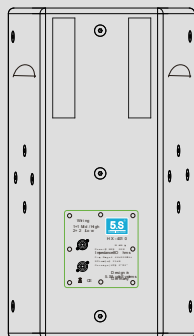

背面(Back)

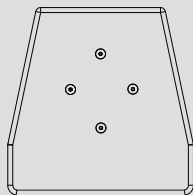

顶部(Top)

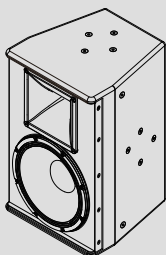

侧面(Side)

HX-4010/4012

FULLRANGE LOUDSPEAKER



技术参数(Technical Parameters)

型号: (Model)	HX-4010	HX-4012
类型: (Type)	2路全频多用途扬声器系统(Two-way FullRange & multi-functional loudspeaker system)	2路全频多用途扬声器系统(Two-way FullRange & multi-functional loudspeaker system)
频率响应: (Frequency Response)	50Hz-20kHz	40Hz-20kHz
功率: (Rated Power)	300W	500W
峰值功率: (Peak Power)	1200W	2000W
阻抗: (Impedance)	8Ω	8Ω
覆盖角度: (Dispersion HxV)	90° *60°	90° *60°
灵敏度: (Sensitivity)	95dB	96dB
最大声压级: (SPL)	126dB	129dB
分频点: (Crossover Point)	1.5kHz 内置分频 (Passive Crossover)	1.3kHz 内置分频 (Passive Crossover)
输入连接器: (Connectors)	2*Neutrik™ 1+1-	2*Neutrik™ 1+1-
低频: (LF)	10"喇叭单元组件采用欧洲定制定制低音单元, 2.5"(63mm)音圈,额定功率为:300W(AES) 10" loudspeaker module, originally imported from European; Voice coil: 2.5" (63mm). Rated power: 300W (AES)	12"喇叭单元组件采用欧洲定制定制低音单元, 3"(75mm)音圈,额定功率为:500W(AES) 12" loudspeaker module, originally imported from European; Voice coil: 3" (75mm). Rated power: 500W (AES)
高频: (HF)	1"喉口喇叭单元,采用欧洲定制定制压缩驱动单元, 1.75"(44mm)音圈,额定功率为: 80W(AES) 1" horn, customized compression drivers originally imported from European; Voice coil: 1.75"(44mm) Rated power: 80W (AES)	1"喉口,采用欧洲定制高音压缩驱动单元, 1.75"(44mm)音圈,额定功率为: 80W(AES) 1" horn, customized compression drivers originally imported from European; Voice coil: 1.75"(44mm) Rated power: 80W (AES)
箱体材料: (Enclosure Materials)	15mm航海级桦木夹板 (15mm marine-grade Birch Plywood)	15mm航海级桦木夹板 (15mm marine-grade Birch Plywood)
箱体表面处理: (Enclosure Paint)	黑色聚脲油漆(Black Polyurea paint)	黑色聚脲油漆(Black Polyurea paint)
尺寸: (Dimensions)	295mm*540mm *340mm(W*H*D)	360mm*605mm*380mm(W*H*D)
重量: (Weight)	16.25kg	20.5kg

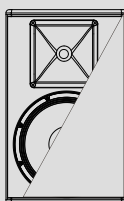
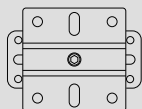

剖面(section)

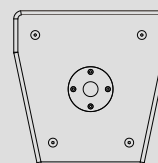

底部(Bottom)



HX-12D/15D

FULLRANGE LOUDSPEAKER

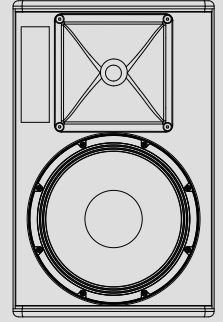

正面(Front)

技术参数(Technical Parameters)

型号: (Model)	HX-12D	HX-15D
类型: (Type)	2路全频多用途扬声器系统(Two-way FullRange & multi-functional loudspeaker system)	2路全频多用途扬声器系统(Two-way FullRange & multi-functional loudspeaker system)
频率响应: (Frequency Response)	52Hz-20kHz	45Hz-18kHz
功率: (Rated Power)	450W	500W
峰值功率: (Peak Power)	1800W	2000W
阻抗: (Impedance)	8Ω	8Ω
覆盖角度: (Dispersion HxV)	90° *60°	90° *60°
灵敏度: (Sensitivity)	96dB	98dB
最大声压级: (SPL)	126dB	130dB
分频点: (Crossover Point)	1.5kHz 内置分频 (Passive Crossover)	1.5kHz 内置分频 (Passive Crossover)
输入连接器: (Connectors)	2*Neutrik™ 1+1-	2*Neutrik™ 1+1-
低频: (LF)	12"喇叭单元组件采用欧洲定制低音单元, 3"(75mm)音圈,额定功率为:450W(AES) 12" loudspeaker , originally imported from European; Voice coil: 3" (75mm). Rated power: 450W (AES)	15"喇叭单元组件采用欧洲进口低音单元, 3"(75mm)音圈,额定功率为:500W(AES) 12" loudspeaker module, originally imported from European;Voice coil: 3" (75mm). Rated power: 500W (AES)
高频: (HF)	1"喉口喇叭单元,采用欧洲定制压缩驱动单元, 1.75"(44mm)音圈,额定功率为: 80W(AES) 1" horn, customized compression drivers originally imported from European; Voice coil: 1.75"(44mm) Rated power: 80W (AES)	1"喉口,采用欧洲高音压缩驱动单元, 2.35"(61mm)音圈, 额定功率为: 100W(AES) 1" horn, customized compression drivers originally imported from European; Voice coil: 2.35"(61mm) Rated power: 100W (AES)
箱体材料: (Enclosure Materials)	15mm航海级桦木夹板 (15mm marine-grade Birch Plywood)	15mm航海级桦木夹板 (15mm marine-grade Birch Plywood)
箱体表面处理: (Enclosure Paint)	黑色水性酒点漆(Black waterborne paints)	黑色水性酒点漆(Black waterborne paints)
尺寸: (Dimensions)	351mm*575mm*353mm(W*H*D)	439mm*705mm*440mm(W*H*D)
重量: (Weight)	22.1kg	36.2kg

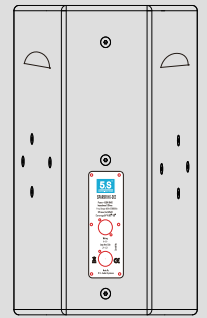

背面(Back)

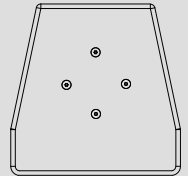

顶面(Top)

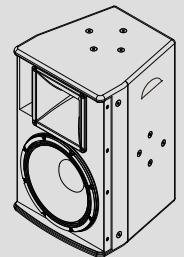

侧面(Side)

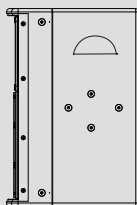

侧面(Side)

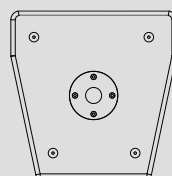

底部(Bottom)

